

POOH BEAR with Vest

A
F
B

3
19
98

①
Start with
a snug
fish base,
small flaps
pointing
down.

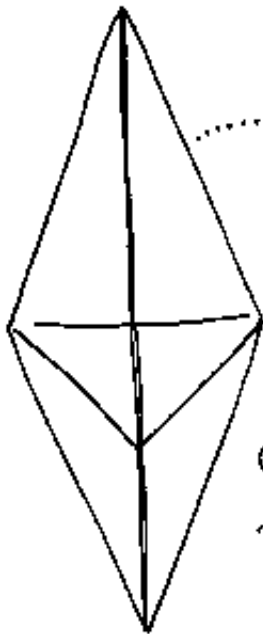

②
Rabbit
ear

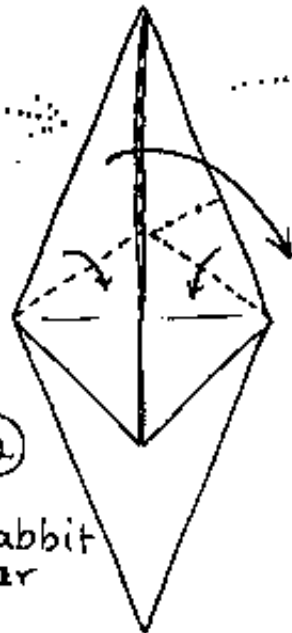

③
Lift
flap &
squash.

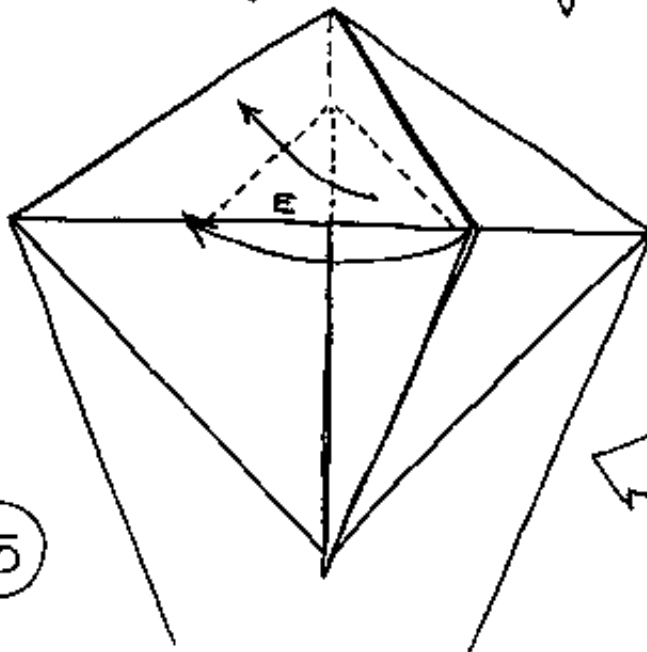
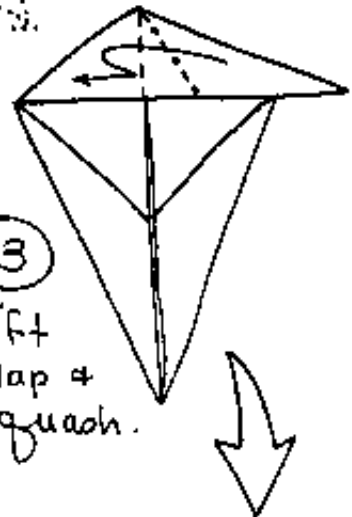

⑤
Enlarged detail. Lift the folded
edge of paper (marked E) and
fold as shown, while returning
flap to left.

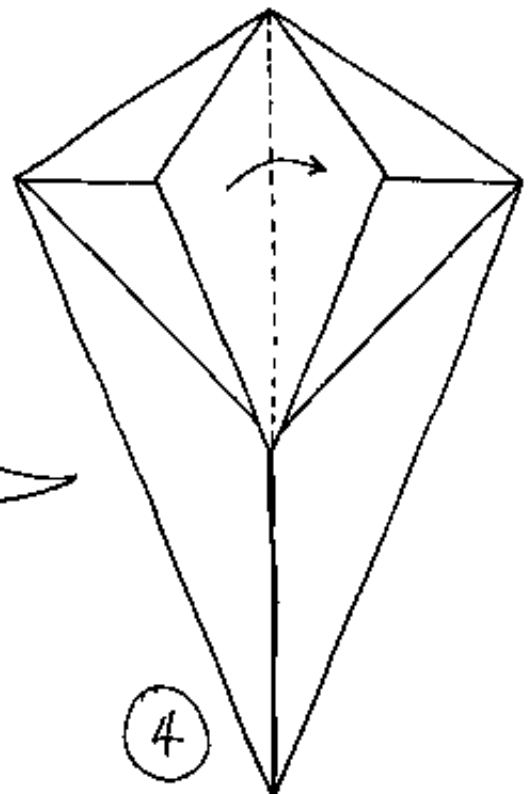

④
Valley-fold flap
softly.

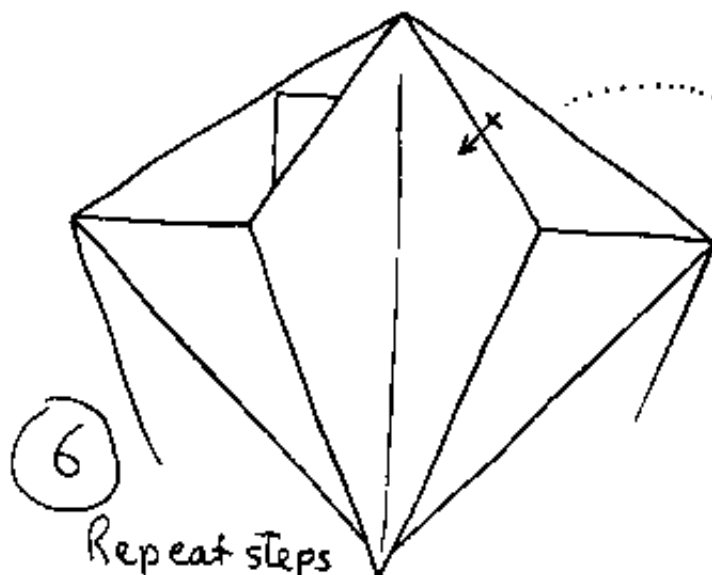

6 Repeat steps 4 & 5 on the right.

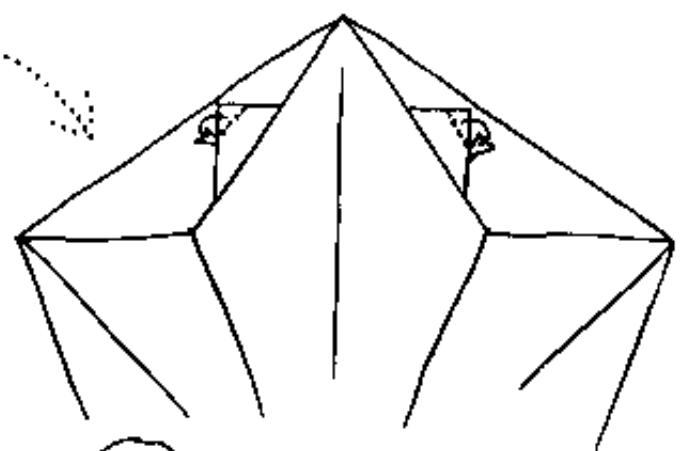

7 Blunt the ears by small inside reverse folds.

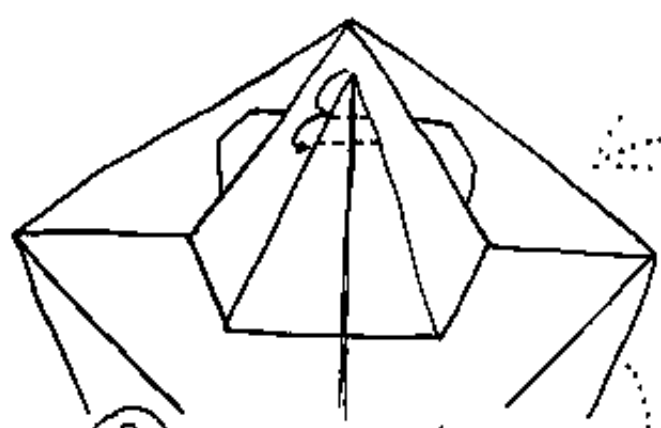

9 VF two times.

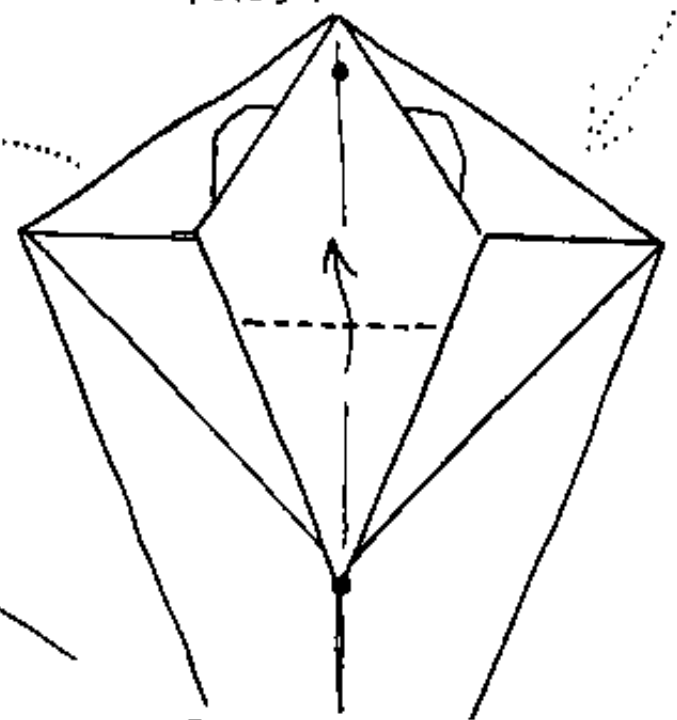

8 VF, dot to dot.

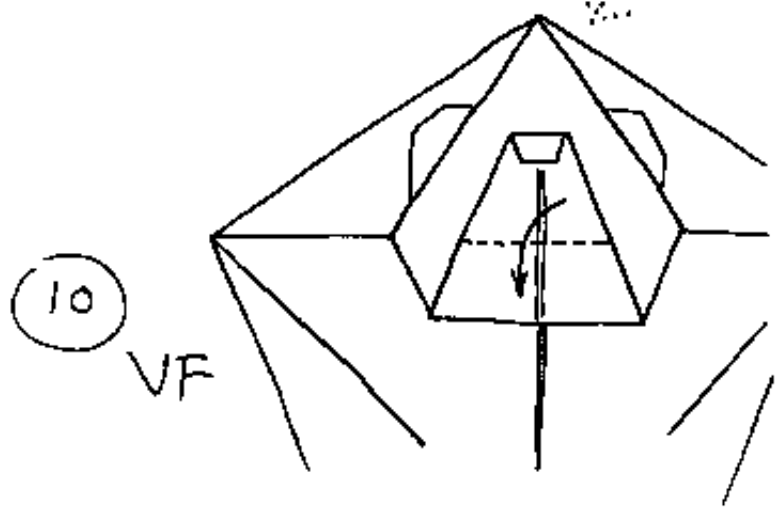

10 VF

Pook, page 3

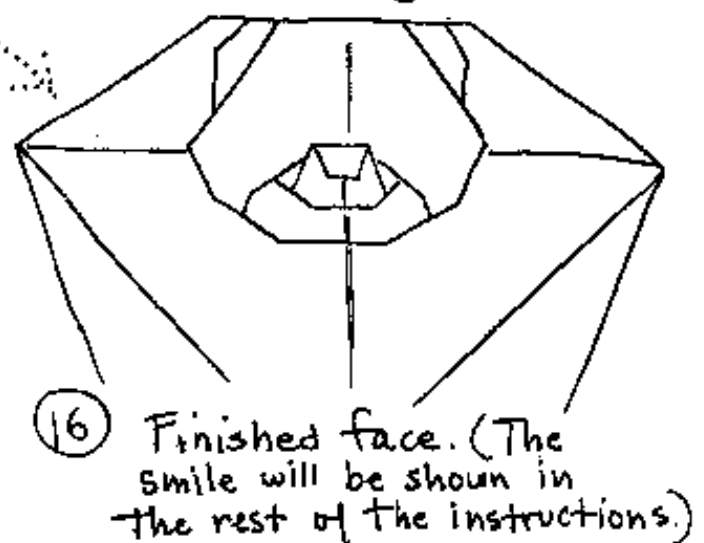
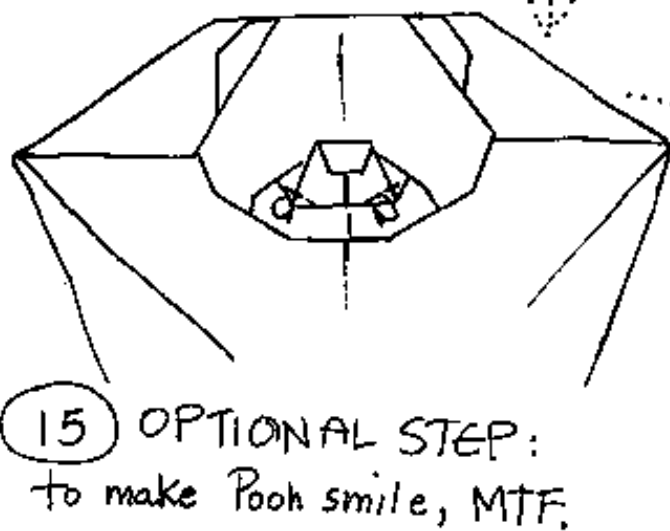
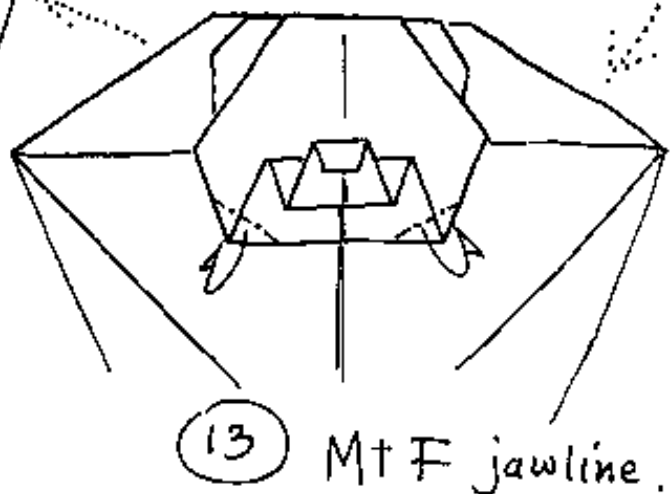
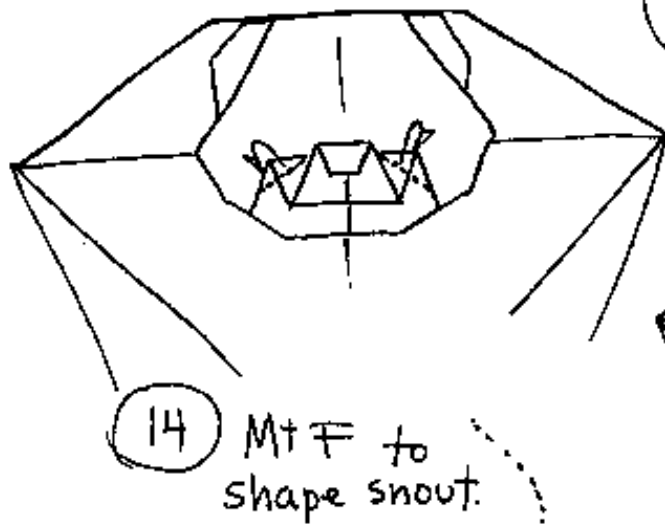
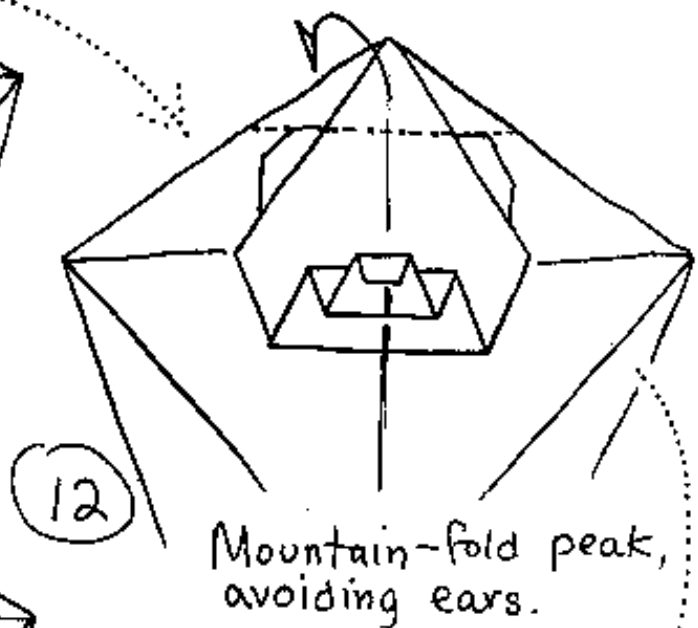
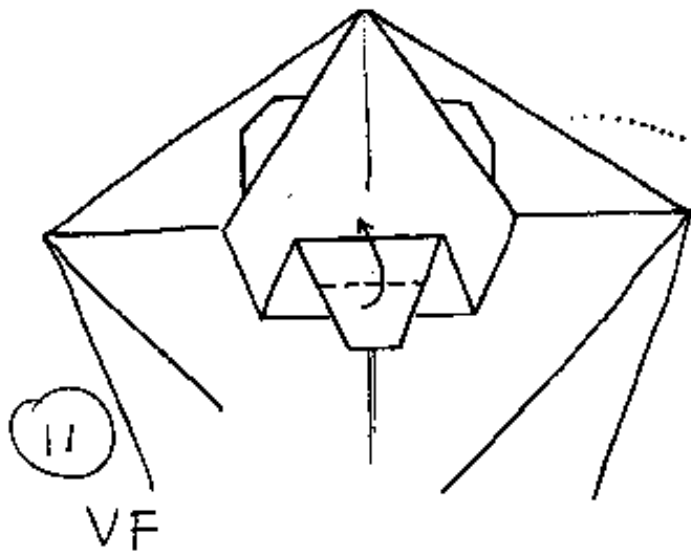

Pook, page 4

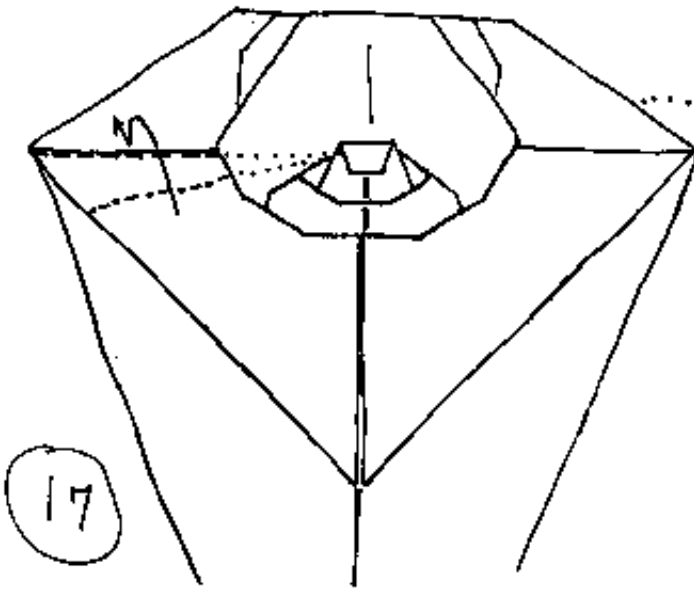

17

Pivot the left flap in a radial pleat.

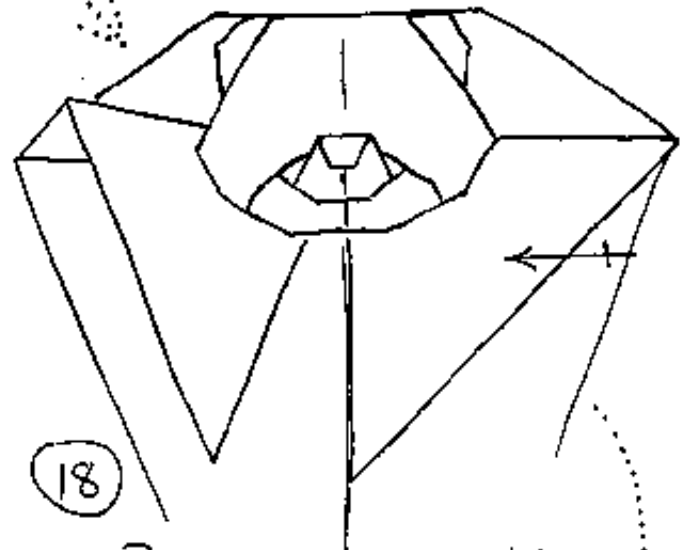

18

Repeat on the right.

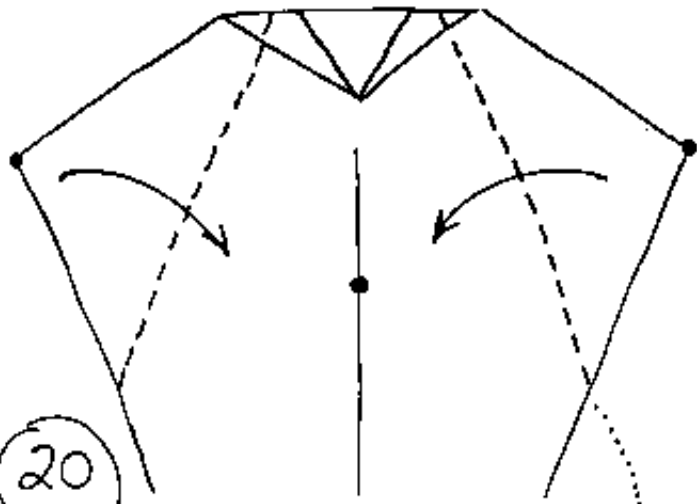

20

VF at angle shown.

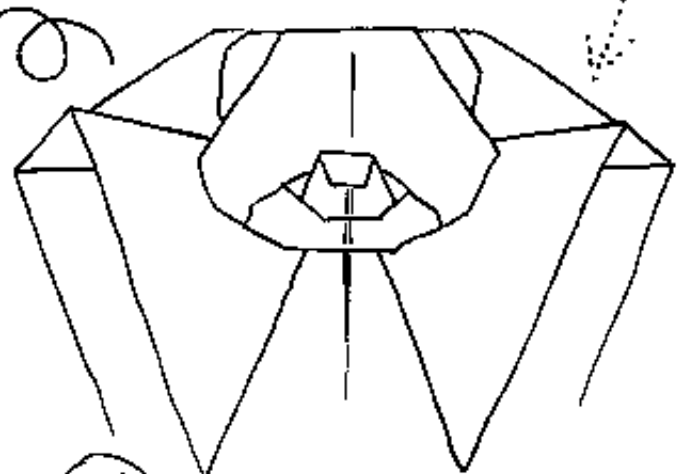

19

Flip the model over

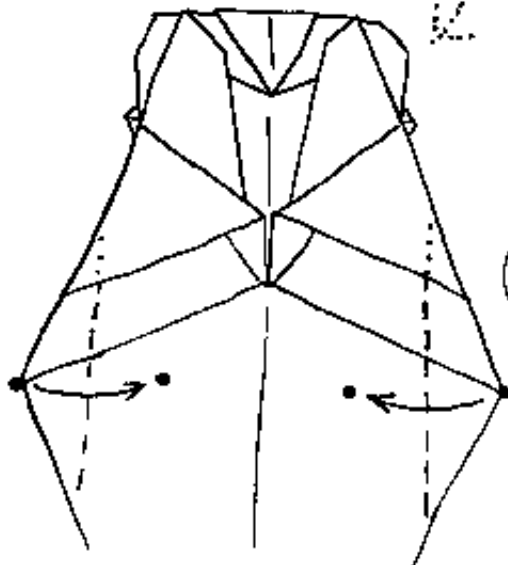

21

VF each side again, extending fold underneath the triangle of the shoulders and leaving the arms free.

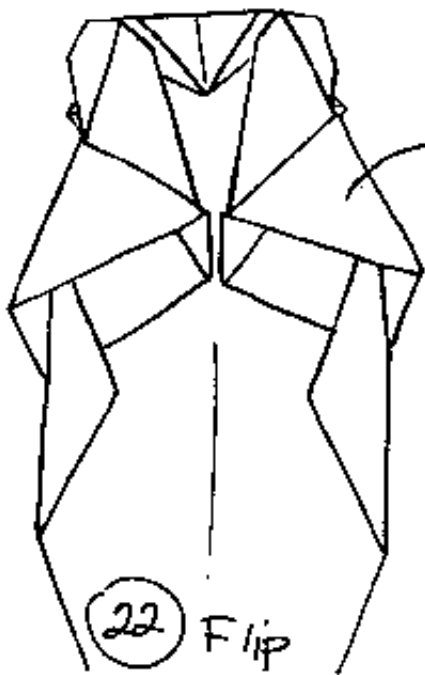

22 Flip

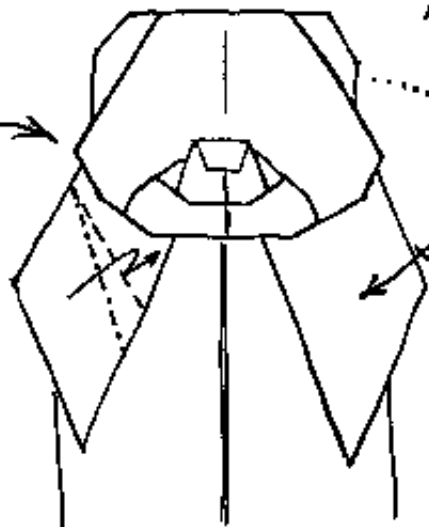

23 Radial-pleat each arm, swiveling up.

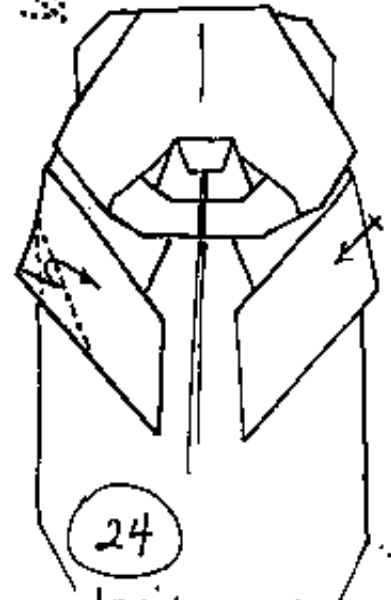

24

Inside-reverse-fold; repeat on right.

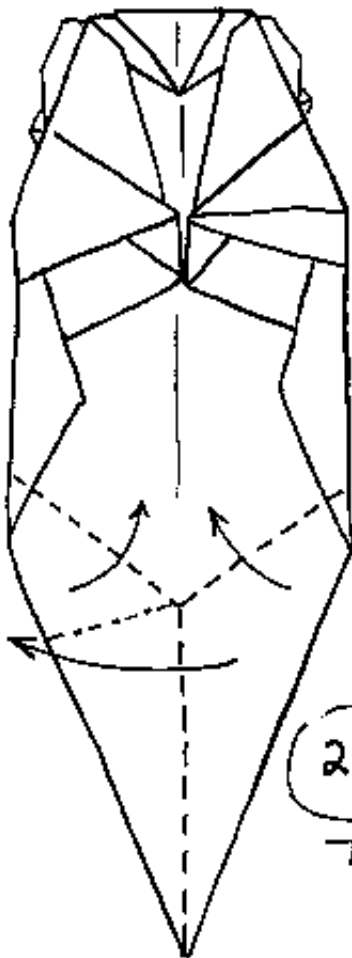

27 Rabbit-ear the lower flap.

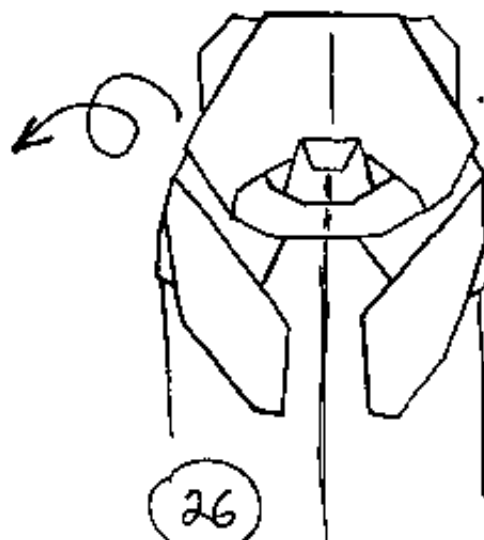

26 Flip.

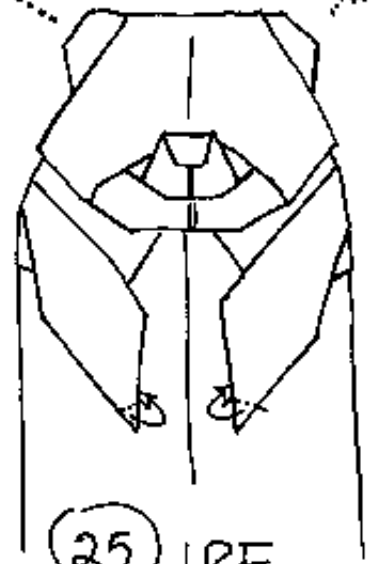

25 IRF to blunt arms.

Pook, page 6

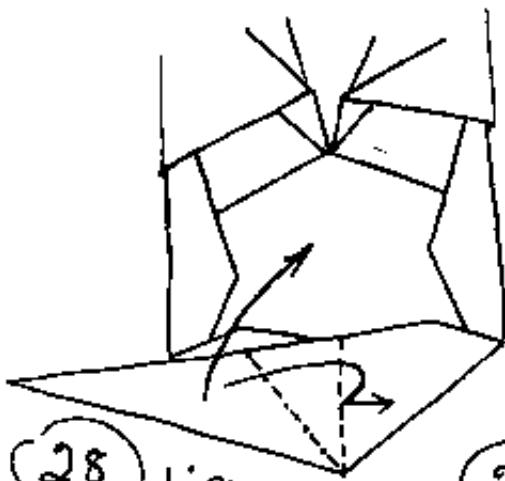

28 Lift and squash-fold.

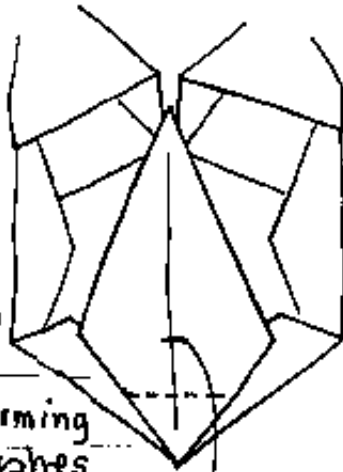

29 VF, forming squashes underneath.

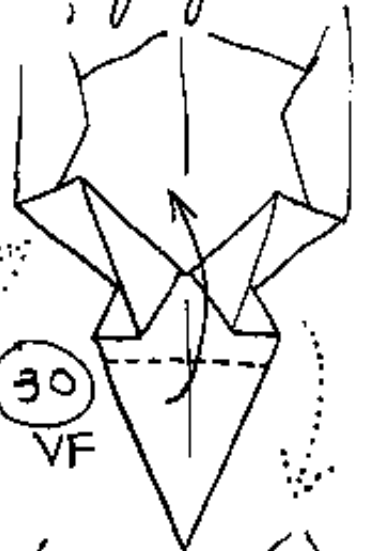

30 VF

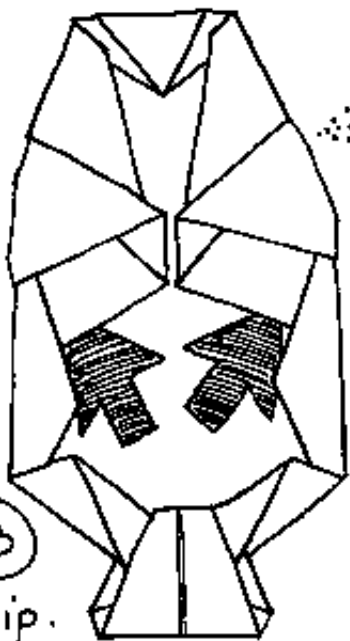

33 Flip.

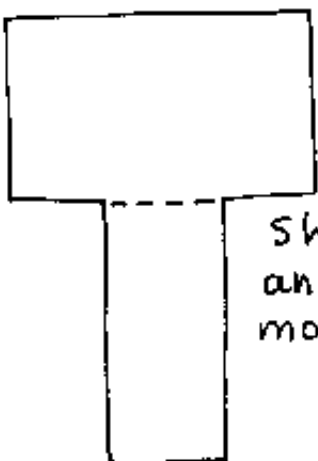

32 From thin cardboard, cut a T-shaped stand and insert in model.

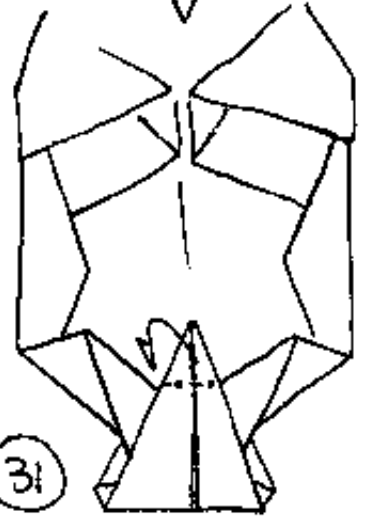

31 MTF, tucking tip in.

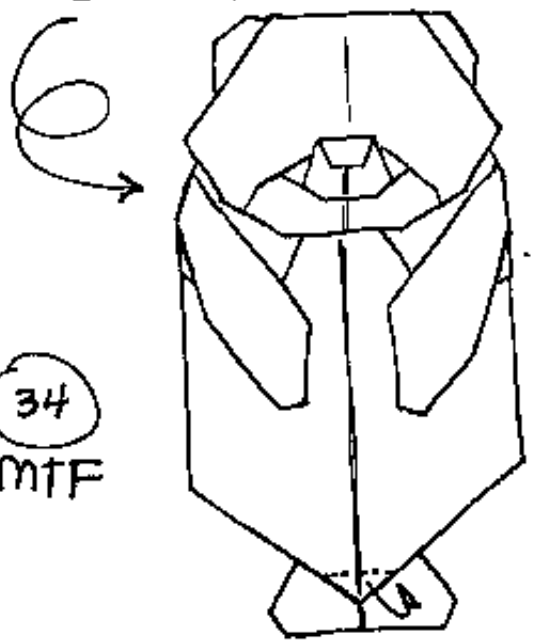

34 MTF

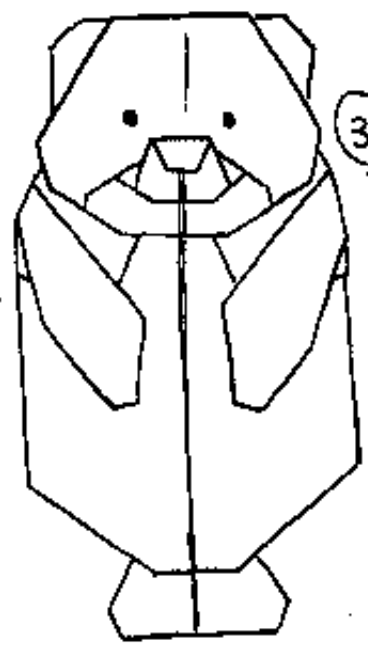

35 Finished Pook Bear.

Note: Eyes are optional.