

“Венера Каменного Века”

Автор: Анита Барбор (США)

STONE AGE VENUS

Use a square of brown or gray textured paper. 6" paper yields a 4½" tall model.
Fold a snug fish base (i.e. no gaps.)



AFB

12
17
99

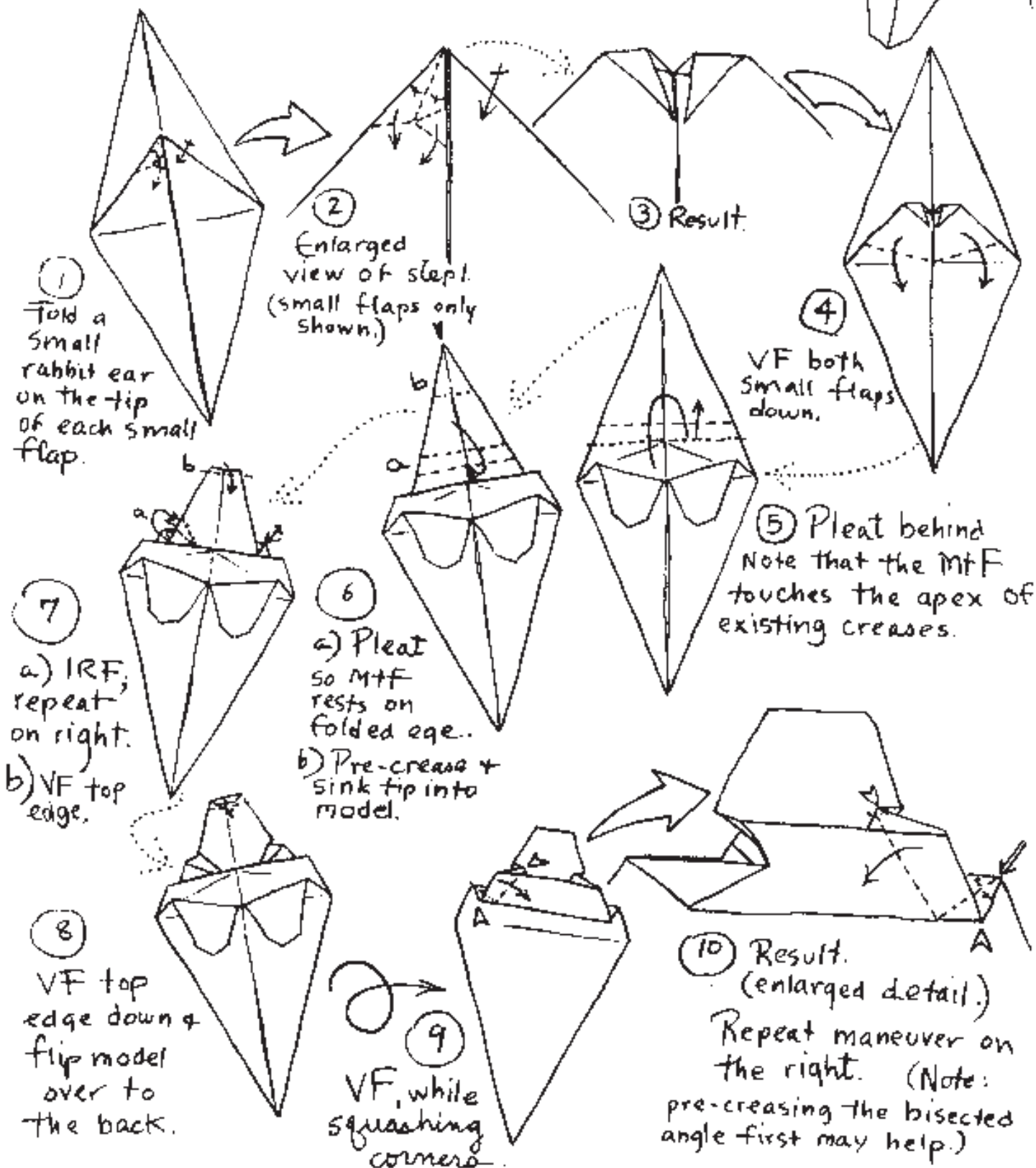

Stone Age Venus,
p. 2

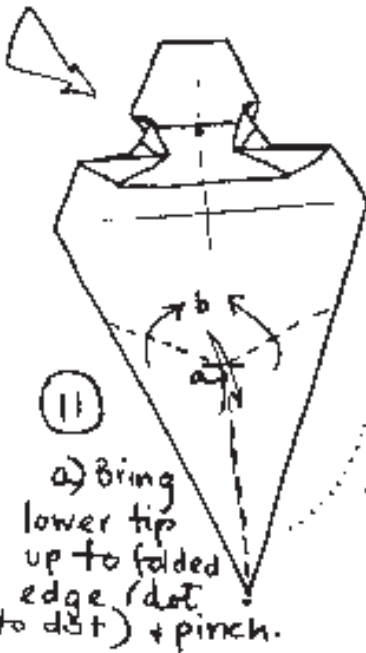

11
a) Bring lower tip up to folded edge (dot to dot) + pinch.
b) VF a shallow vee, bringing flap upright (i.e., perpendicular to plane of model.)

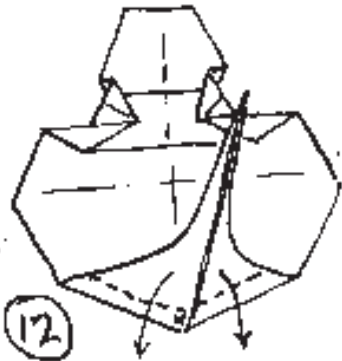

12
Spread the layers of the upright flap out to the sides and VF them down. Push down at X and flatten flap, forming a tuck down the middle.

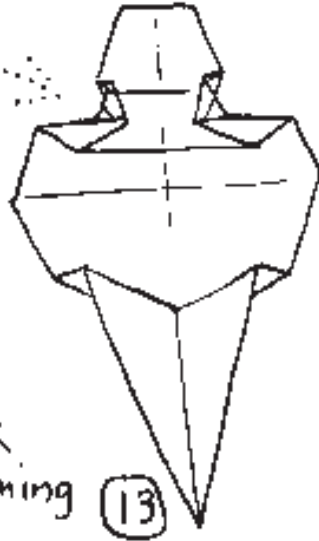

13
Turn model over + unfold steps 11 + 12.

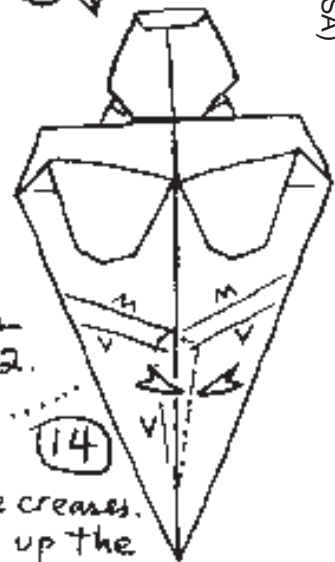

14
Note creases. Pinch up the MFFs shown + refold all nearby existing creases except the middle vertical.

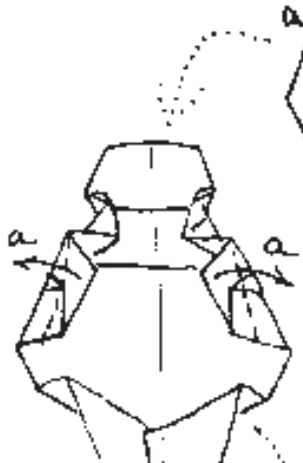

15
a) VF top edge once more.
b) Curve this band slightly back and flip model over.



16
a) VF both sides.
b) VF.

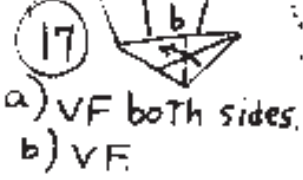

17
a) VF both sides.
b) VF.

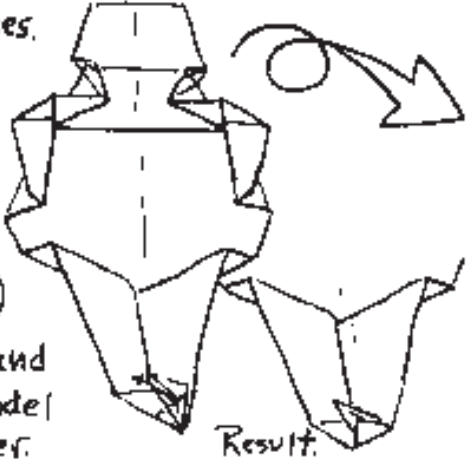

18
VF and flip model over.

Result.

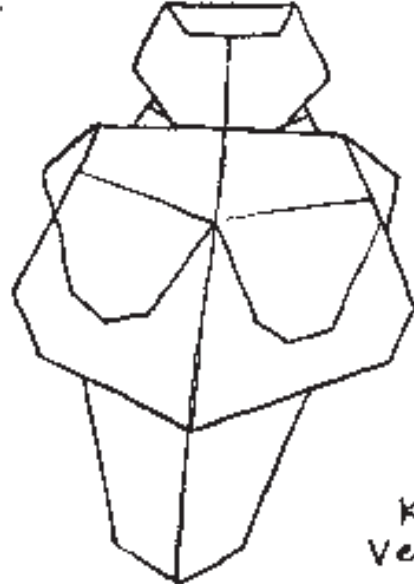

The stone carving known as the Venus of Willendorf.