

# The ONE DOLLAR TANK

BY: Charles Esseltine  
10/99

1.) PRECREASE A DOLLAR BILL



2.) MAKE A WATER BOMB BASE FROM THE MIDDLE SQUARE



3.)

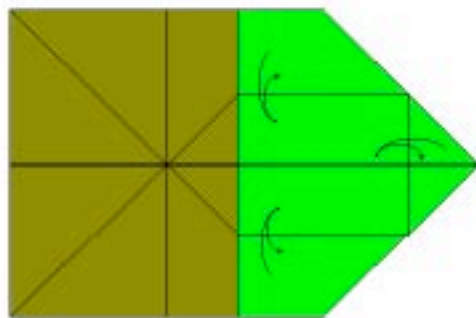

6.)

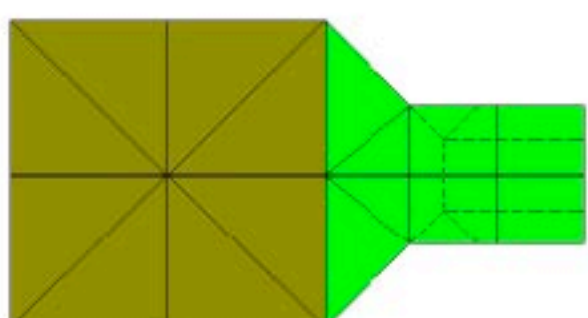

4.)

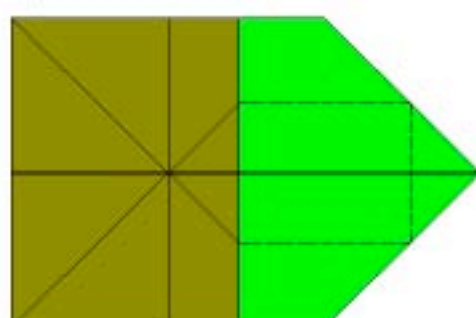

7.)

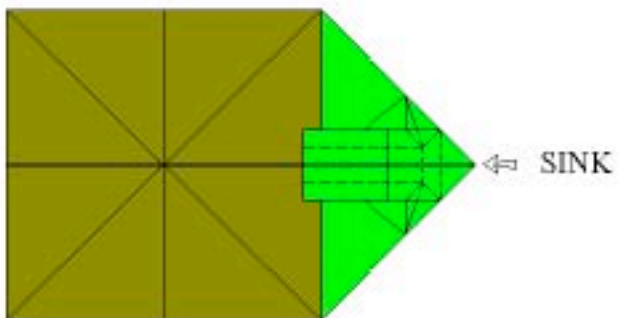

5.)

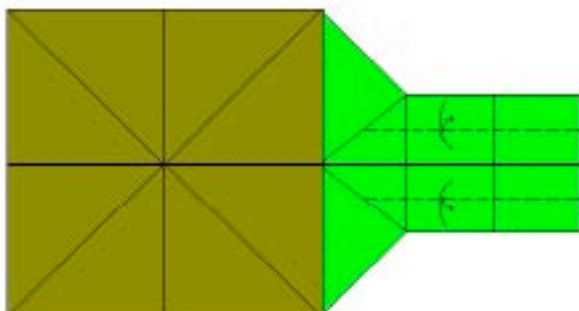

8.)

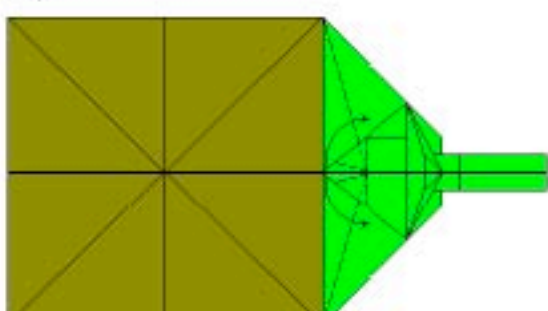

9.)

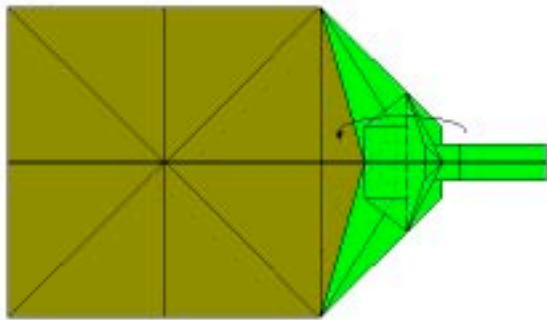

10.)

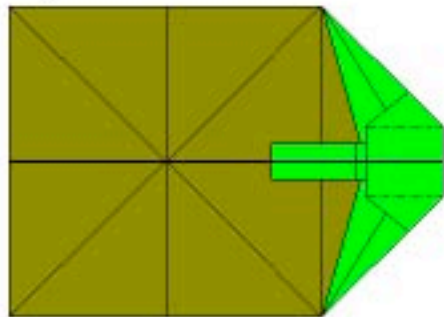

11.)

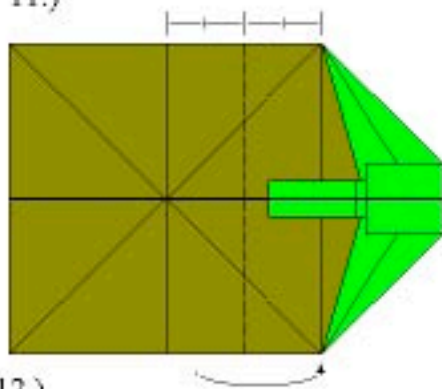

12.)

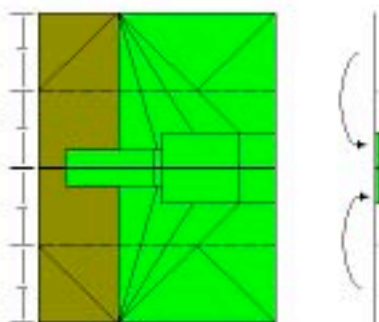

13.)

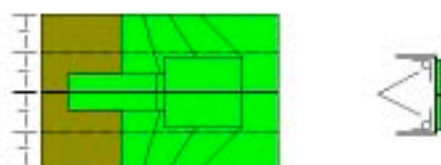

14.)

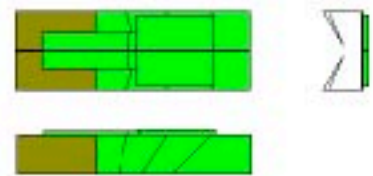

15.)

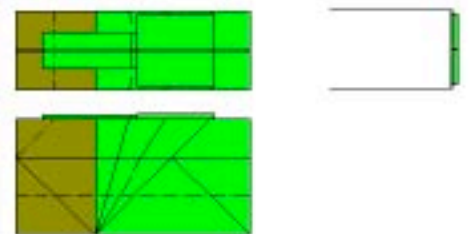

16.)

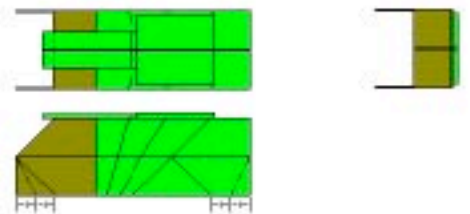

17.) Push in on the sides of the turret.

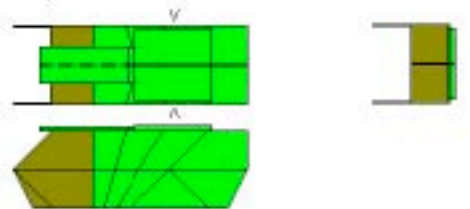

18.) Round out the barrel.

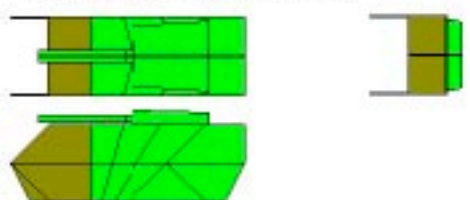

DONE !

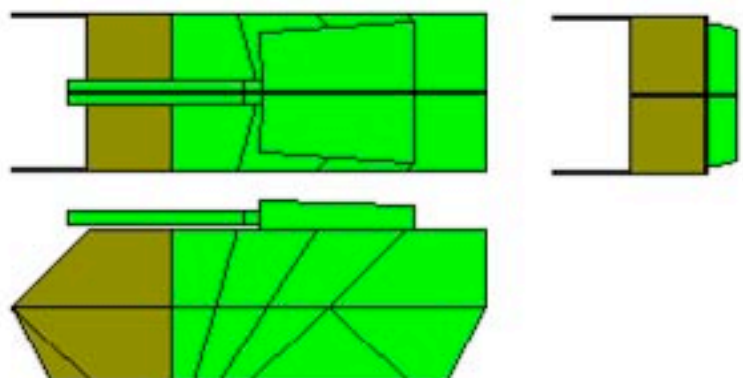

The ONE DOLLAR TANK. An just think, the army pays over a billion dollars for ONE tank. Think of how many you could fold with that kind of money!